



# Grillo

AGRIGARDEN MACHINES



# GZ

## 120-123-220-223



GZ 120



GZ 223

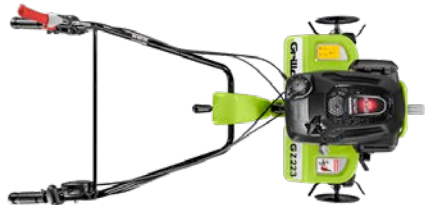









GZ 223



GZ 123



GZ 220

|               |  | HP-kW           | CC    | <br>L (US qts) |  |  |  |  |  | <br>kg (lb) |
|---------------|---|-----------------|-------|---|---|---|---|---|---|--|
| <b>GZ 120</b> | RVM120<br>RATO  | HP 2.7 - kW 2   | 120/1 | 0,8 (0.84)  |  | 155 rpm   | --  | A 28 cm<br>(11 in)  | 52 cm<br>(20 in)  | 35 (77)  |
| <b>GZ 123</b> | GCV 170<br>Honda  | HP 4.8 - kW 3.6 | 166/1 | 0,9 (0.95)  |  | 155 rpm   | --  | A 28 cm<br>(11 in)  | 75 cm<br>(29.5 in)  | 39 (86)  |
| <b>GZ 220</b> | RVM120  | HP 2.7 - kW 2   | 120/1 | 0,8 (0.84)  |  | 155 rpm   | Max 2,1 km/h<br>(1.3 mph)   | A 28 cm<br>(11 in)  | 52 cm<br>(20 in)  | 41 (90)  |
| <b>GZ 223</b> | GCV 170<br>Honda  | HP 4.8 - kW 3.6 | 166/1 | 0,9 (0.95)  |  | 155 rpm   | Max 2,1 km/h<br>(1.3 mph)   | A 28 cm<br>(11 in)  | 75 cm<br>(29.5 in)  | 45 (99)  |

# PRINCESS

## M1 - MR









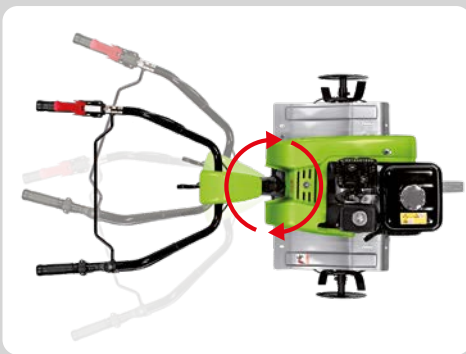



PRINCESS MR



PRINCESS M1



|           |  | HP-kW           | CC    | <br>L (US qts) |  |  |  |  |  | <br>kg (lb) |
|-----------|---|-----------------|-------|---|---|---|---|---|---|--|
| <b>M1</b> | G 200 FA<br>Loncin  | HP 5.5 - kW 4.1 | 196/1 | 3 (3.2)   |  | ① 132 rpm   | --  | A 32 cm<br>(12 in)  | 30-52-77 cm<br>(12-20-30 in)  | 62 (137)   |
| <b>MR</b> | G 200 FA<br>Loncin  | HP 5.5 - kW 4.1 | 196/1 | 3 (3.2)   |  | ① 132 rpm   | Max<br>2,3 km/h<br>(1.4 mph)  | A 32 cm<br>(12 in)  | 30-52-77 cm<br>(12-20-30 in)  | 64 (141)   |
|           | GX 200<br>Honda   | HP 5.5 - kW 4.1 | 196/1 | 3,1 (3.3)   |   |   |   |   |   | 62 (137)   |

# PRINCESS

## MP3 - MP3 PRO



PRINCESS MP3



PRINCESS MP3 PRO

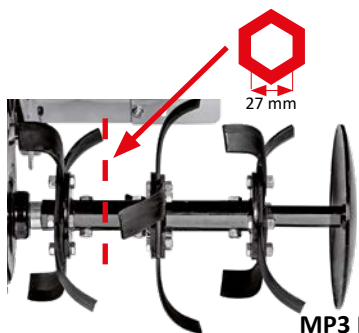

MP3 PRO



MP3



MP3 LABOUR KIT

|                |                    | HP-kW           | CC    | <br>L (US qts) |  |                       |                              |                    |                              | <br>kg (lb) |
|----------------|--------------------|-----------------|-------|----------------|--|-----------------------|------------------------------|--------------------|------------------------------|-------------|
| <b>MP3</b>     | G 200 FA<br>Loncin | HP 5.5 - kW 4.1 | 196/1 | 3 (3.2)        |  | Ⓛ 36 rpm<br>Ⓜ 160 rpm | Max<br>2,3 km/h<br>(1.4 mph) | A 32 cm<br>(12 in) | 30-52-77 cm<br>(12-20-30 in) | 65 (143)    |
| <b>MP3 PRO</b> | G 200 FA<br>Loncin | HP 5.5 - kW 4.1 | 196/1 | 3 (3.2)        |  | Ⓛ 36 rpm<br>Ⓜ 160 rpm | Max<br>2,3 km/h<br>(1.4 mph) | A 32 cm<br>(13 in) | 56-82 cm<br>(22-32 in)       | 68 (150)    |
|                | GX 200<br>Honda    | HP 5.5 - kW 4.1 | 196/1 | 3,1 (3.3)      |  | Ⓛ 36 rpm<br>Ⓜ 160 rpm | Max<br>2,3 km/h<br>(1.4 mph) | A 32 cm<br>(13 in) | 56-82 cm<br>(22-32 in)       | 66 (145)    |

# HR7 PRO



HR78 PRO



HR78 PRO



HR76 PRO



HR75 PRO



|                 |                    | HP-kW           | CC/<br> | <br>L (US qts)          |  |                                    |                            |                    |                               | <br>kg (lb) |
|-----------------|--------------------|-----------------|---------|-------------------------|--|------------------------------------|----------------------------|--------------------|-------------------------------|-------------|
| <b>HR75 PRO</b> | G 200 FA<br>Loncin | HP 5.5 - kW 4.1 | 196/1   | <br>3 (3.2)             |  |                                    |                            |                    |                               | 83 (183)    |
| <b>HR76 PRO</b> | G 300 FA<br>Loncin | HP 9.3 - kW 6.8 | 302/1   | <br>6,1 (5.6)           |  | ① 53 rpm<br>② 123 rpm<br>③ 162 rpm | Max<br>3 km/h<br>(1.8 mph) | A 32 cm<br>(12 in) | 58-85-111 cm<br>(23-33-43 in) | 95 (209.4)  |
| <b>HR77 PRO</b> | SH178 FA<br>Norwik | HP 5.3 - kW 4   | 306/1   | Diesel<br><br>3,5 (3.6) |  |                                    |                            |                    |                               | 97 (213.8)  |
| <b>HR78 PRO</b> | SH178 FA<br>Norwik | HP 5.3 - kW 4   | 306/1   | Diesel<br><br>3,5 (3.6) |  |                                    |                            |                    |                               | 105 (231.4) |

# 11500

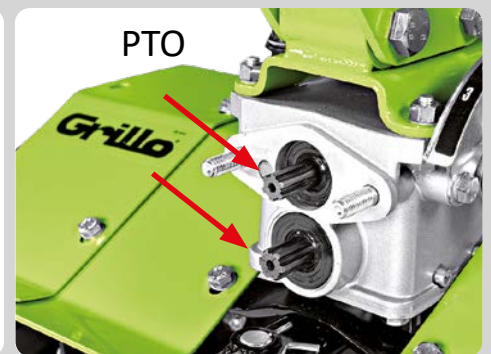
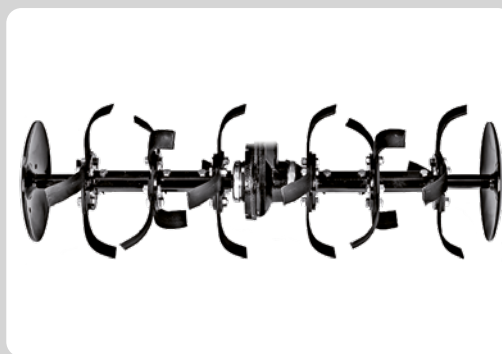

|       |                    | HP-kW           | CC/   | <br>L (US qts)      |  |                                    |                            |                      |                               | <br>kg (lb)            |
|-------|--------------------|-----------------|-------|---------------------|--|------------------------------------|----------------------------|----------------------|-------------------------------|------------------------|
| 11500 | GX 200<br>Honda    | HP 5.5 - kW 4.1 | 196/1 | 3,1 (3.3)           |  |                                    |                            |                      |                               | 82 (180.7)             |
|       | GX 270<br>Honda    | HP 8.4 - kW 6.3 | 270/1 | 5,3 (5.6)           |  | ① 53 rpm<br>② 123 rpm<br>③ 162 rpm | Max<br>3 km/h<br>(1.8 mph) | A 34 cm<br>(13.4 in) | 59-86-112 cm<br>(23-34-44 in) | 90 (198.4)<br>98 (216) |
|       | KD15 350<br>Kohler | HP 7.5 - kW 5.5 | 349/1 | Diesel<br>4,3 (4.5) |  |                                    |                            |                      |                               | 121 (266.7)            |

# G 45

## COUNTER-ROTATING TILLER



|             |                    | HP-kW           | CC/   | <br>L (US qts) |  |                                    |                                      |                    |                  |          |
|-------------|--------------------|-----------------|-------|----------------|--|------------------------------------|--------------------------------------|--------------------|------------------|----------|
| <b>G 45</b> | G 200 FA<br>Loncin | HP 5.5 - kW 4.1 | 196/1 | 3 (3.2)        |  | 4.00-8<br>1,6 km/h<br>(1 mph)<br>→ | 4.00-8<br>2,5 km/h<br>(1.5 mph)<br>← | A 26 cm<br>(10 in) | 50 cm<br>(20 in) | 82 (181) |

# G 46

## COUNTER-ROTATING TILLER



|             |                 | HP-kW           | CC    | L (US qts) |  |                                    |                                    |                    |                  | kg (lb)  |
|-------------|-----------------|-----------------|-------|------------|--|------------------------------------|------------------------------------|--------------------|------------------|----------|
| <b>G 46</b> | GX 200<br>Honda | HP 5.5 - kW 4.1 | 196/1 | 3,1 (3.3)  |  | 4.00-8<br>1,6 km/h<br>(1 mph)<br>→ | 4.00-8<br>1,6 km/h<br>(1 mph)<br>← | A 26 cm<br>(10 in) | 50 cm<br>(20 in) | 98 (216) |

# G 52



























|             |                    | HP-kW           | CC    | <br>L (US qts) |                            |                            |                    |                        |          |
|-------------|--------------------|-----------------|-------|----------------|----------------------------|----------------------------|--------------------|------------------------|----------|
| <b>G 52</b> | G 200 FA<br>Loncin | HP 5.5 - kW 4.1 | 196/1 | 3 (3.2)        | 13x5.00-6                  | 13x5.00-6                  | A 26 cm<br>(10 in) | 37-50 cm<br>(15-20 in) | 67 (148) |
|             |                    |                 |       |                | 1,4 km/h<br>(0.9 mph)<br>→ | 2,2 km/h<br>(1.4 mph)<br>→ |                    |                        |          |
|             |                    |                 |       |                | 2,2 km/h<br>(1.4 mph)<br>← | 1,4 km/h<br>(0.9 mph)<br>← |                    |                        |          |

# G 55



LABOUR KIT



|             |  | HP-kW           |  CC |  L (US qts) |  |   |    |                     |                   |  kg (lb) |
|-------------|---|-----------------|--|--|---|--|---|--|--|---|
| <b>G 55</b> | G 200 FA<br>Loncin  | HP 5.5 - kW 4.1 | 196/1  |  3 (3.2)    |  |  4.00-8   |  4.00-8   |  A 26 cm<br>(10 in) |  58 cm<br>(23 in) | 89 (196)  |
|             | GX 200<br>Honda   | HP 5.5 - kW 4.1 | 196/1  |  3,1 (3.3)  |  |  4.00-8<br> 1,1 km/h (0.7 mph)<br> 2,6 km/h (1.6 mph)<br> 1,1 km/h (0.7 mph)<br> 2,6 km/h (1.6 mph) |  4.00-8<br> 1,1 km/h (0.7 mph)<br> 2,6 km/h (1.6 mph)<br> 1,1 km/h (0.7 mph)<br> 2,6 km/h (1.6 mph) |  |  | 87 (192)  |

# G 84



## FORWARD AND COUNTER-ROTATING TILLER

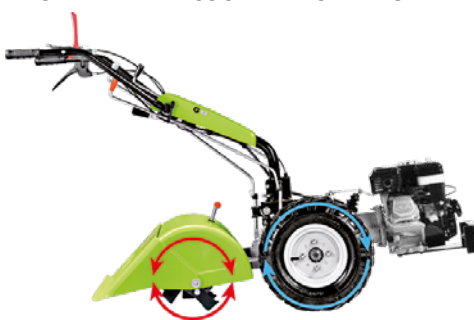















|             |                 | HP-kW           | CC    | <br>L (US qts) |  |  |  |                 |                           | <br>kg (lb) |
|-------------|-----------------|-----------------|-------|----------------|--|--|--|-----------------|---------------------------|-------------|
| <b>G 84</b> | GX 200<br>Honda | HP 5.5 - kW 4.1 | 196/1 | 3,1 (3.3)      |  | 4.00-8<br>1,1 km/h (0.7 mph)<br>2,6 km/h (1.6 mph) | 4.00-8<br>1,1 km/h (0.7 mph)<br>2,6 km/h (1.6 mph) | A 32 cm (12 in) | 37-47-58 cm (15-19-23 in) | 111 (245)   |

# G 85d



## FORWARD AND COUNTER-ROTATING TILLER



|              |  | HP-kW           | CC    | <br>L (US qts) |  | <br>DIFF. LOCK |          |         |  |  | <br>kg (lb) |
|--------------|---|-----------------|-------|---|---|---|---|--|---|---|--|
| <b>G 85d</b> | G 300 FA<br>Loncin  | HP 9.3 - kW 6.8 | 302/1 | 6,1 (6.4)   |  | ✓   |  4.00-10 |  4.00-10 |   |   | 127 (280)  |
|              | GX 270<br>Honda   | HP 8.4 - kW 6.3 | 270/1 | 5,3 (5.6)   |  | ✓   | ⓘ 1,3 km/h<br>(0.8 mph)   | ⓘ 1,3 km/h<br>(0.8 mph)  |   |   | 127 (280)  |
|              | R 300 D<br>Rato   | HP 8.2 - kW 6   | 301/1 | 5,4 (5.7)   |  | ✓   | Ⓜ 3,0 km/h<br>(1.9 mph)<br>➔  | Ⓜ 3,0 km/h<br>(1.9 mph)<br>➔   | A 32 cm<br>(12 in)  | 37-47-58-68-<br>77 cm<br>(15-19-23-27-<br>30 in)                                      | 142 (313)  |
|              | KD15 350<br>Kohler  | HP 7.5 - kW 5.5 | 349/1 | Diesel<br>4,3 (4.5)   |  | ✓   | ⓘ 1,3 km/h<br>(0.8 mph)<br>Ⓜ 3,0 km/h<br>(1.9 mph)<br>➔                                     | ⓘ 1,3 km/h<br>(0.8 mph)<br>Ⓜ 3,0 km/h<br>(1.9 mph)<br>➔                                      |   |   | 151 (332)  |

# G 107d



|               |                    | HP-kW           | CC    | <br>L (US qts)        |  | <br>DIFF. LOCK |   |   |                        |  | <br>kg (lb) |
|---------------|--------------------|-----------------|-------|-----------------------|--|----------------|---|---|------------------------|--|-------------|
| <b>G 107d</b> | G 300 FA<br>Loncin | HP 9.3 - kW 6.8 | 302/1 | <br>6,1 (6.4)         |  | ✓              | <br>5.00-10   | <br>5.00-10   |                        |  | 136 (300)   |
|               | GX 270<br>Honda    | HP 8.4 - kW 6.3 | 270/1 | <br>5,3 (5.6)         |  | ✓              | <br>1,3 km/h<br>(0.8 mph)<br>2,4 km/h<br>(1.5 mph)<br>3,6 km/h<br>(2.2 mph) | <br>1,3 km/h<br>(0.8 mph)<br>2,4 km/h<br>(1.5 mph)<br>3,6 km/h<br>(2.2 mph) |                        |  | 136 (300)   |
|               | R 300 D<br>Rato    | HP 8.2 - kW 6   | 301/1 | <br>5,4 (5.7)         |  | ✓              | <br>1,3 km/h<br>(0.8 mph)<br>2,4 km/h<br>(1.5 mph)<br>3,6 km/h<br>(2.2 mph) | <br>1,3 km/h<br>(0.8 mph)<br>2,4 km/h<br>(1.5 mph)<br>3,6 km/h<br>(2.2 mph) | <br>A 32 cm<br>(12 in) |  | 150 (330)   |
|               | KD15 440<br>Kohler | HP 11 - kW 8.1  | 441/1 | Diesel<br><br>5 (5.3) |  | ✓              | <br>1,3 km/h<br>(0.8 mph)<br>2,4 km/h<br>(1.5 mph)<br>3,6 km/h<br>(2.2 mph) | <br>1,3 km/h<br>(0.8 mph)<br>2,4 km/h<br>(1.5 mph)<br>3,6 km/h<br>(2.2 mph) |                        | <br>37-47-58-68-<br>77 cm<br>(15-19-23-27-<br>30 in) | 168 (370)   |

# G 108 - G 110

































G 108



G 110

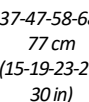

|              |  |  CC/HP<br>HP-kW |  DIESEL<br>L (US qts) |  |  Steering Brakes |  DIFF. LOCK |   |    |                                        |  kg (lb) |
|--------------|---|--|--|---|---|--|--|---|---|---|
| <b>G 108</b> | GX 270<br>Honda   | 270 cc/1<br>HP 8.4 - kW 6.3  |  5,3 (5.6)            |  | ✓   | ✓  |  5.00-10  |  5.00-10  |   | 136 (300)   |
|              | GX 390<br>Honda   | 389 cc/1<br>HP 11.7 - kW 8.7   |  6,1 (6.4)            |  | ✓   | ✓  |  1,3 km/h (0.8 mph)<br> 2,4 km/h (1.5 mph)<br> 4,3 km/h (2.7 mph) |  1,3 km/h (0.8 mph)<br> 2,4 km/h (1.5 mph)<br> 4,3 km/h (2.7 mph) |   | 144 (317)   |
| <b>G 110</b> | KD15 440<br>Kohler  | 441 cc/1<br>HP 11 - kW 8.1   |  Diesel<br>5 (5.3)    |  | ✓   | ✓  |  0,7 km/h (0.4 mph)<br> 1,5 km/h (0.9 mph)<br> 3,2 km/h (2.0 mph) |  0,7 km/h (0.4 mph)<br> 1,5 km/h (0.9 mph)<br> 3,2 km/h (2.0 mph) |  A 32 cm (12.6 in)                     | 168 (370)   |
|              |   |  |  |   |   |  |  |   |  37-47-58-68-77 cm (15-19-23-27-30 in) |   |

# G 131 - G 131 BC



G 131



G 131 BC

























G 131 BC



G 131 BC



G 131 BC

|                 |  | <b>HP-kW</b>          | <b>CC</b><br> | <br>L (US qts) |  | <br>DIFF. LOCK |    |    |                          | <br>kg (lb) |           |
|-----------------|---|-----------------------|--|---|---|---|---|---|---|--|-----------|
| <b>G 131</b>    | KD15 440<br>Kohler  | HP11 - kW8.1          | 441 cc/1   | Diesel<br>5 (5.3)   |  | ✓   | <br>5.00-12  | <br>5.00-12  | <br>A 32 cm<br>(12.6 in) | 55-70-85 cm<br>(22-28-34 in)   | 192 (423) |
| <b>G 131 BC</b> | Vanguard 16<br>B&S  | HP 14 (16*)<br>kW10.3 | 479/2  | 8,5 (8.9)   |  | ✓   | <br>1,2 km/h<br>(0.7 mph)<br><br>2,4 km/h<br>(1.5 mph)<br><br>3,4 km/h<br>(2.1 mph)<br><br>7,1 km/h<br>(4.4 mph)<br>1,7 km/h<br>(1.0 mph)<br><br>3,5 km/h<br>(2.2 mph) | <br>1,7 km/h<br>(1.0 mph)<br><br>3,5 km/h<br>(2.2 mph)<br>→ | <br>A 32 cm<br>(12.6 in) | 55-70-85 cm<br>(22-28-34 in)   | 195 (430) |

\* Gross Power

# DUMPER

## 507- 406





















DUMPER 406



DUMPER 507









|                   |  |  |  |  |  |  |  |  |  |
|-------------------|---|---|---|---|---|---|---|---|---|
| <b>Dumper 406</b> | G 200 FA Loncin   | HP 5.5 - kW 4.1   | 196/1   |  |  | I 1,0 km/h (0.6 mph)<br>II 2,0 km/h (1.2 mph)                                       | I 1,0 km/h (0.6 mph)<br>II 2,0 km/h (1.2 mph)   | 400 kg (882 lb)   | 270 (595)   |
|                   | GX 200 Honda  | HP 5.5 - kW 4.1   | 196/1   |  |  | III 3,5 km/h (2.2 mph)  | III 3,5 km/h (2.2 mph)  |   | 268 (591)   |
| <b>Dumper 507</b> | GX 270 Honda  | HP 8.4 - kW 6.3   | 270/1   |  |  | I 1,0 km/h (0.6 mph)<br>II 2,0 km/h (1.2 mph)                                       | I 1,0 km/h (0.6 mph)<br>II 2,0 km/h (1.2 mph)   | 500 kg (1102 lb)  | 302 (666)   |
|                   | R 300 D Rato  | HP 8.2 - kW 6   | 301/1   |  |  | III 3,5 km/h (2.2 mph)  | II 2,0 km/h (1.2 mph)   |   | 319 (703)   |
|                   | KD15 350 Kohler   | HP 7.5 - kW 5.5   | 349/1   |  |  | IV 8,7 km/h (5.4 mph)   | III 3,5 km/h (2.2 mph)  |   | 337 (743)   |

# HWT 570











## MULTIFORCE



|                           |  |  |  |  |  |  |  |  |  |            |
|---------------------------|---|---|---|---|---|---|--|---|---|------------|
| <b>HWT 570 Multiforce</b> | GCV 170<br>Honda  | HP 4.8 - kW 3.6   | 166/1   | 0,9 (0.95)  |  | --  | 41 cm<br>(16.2 in)   | 15-30-50-60 mm<br>(0.6-1.2-2-2.4 in)  | 60 cm<br>(24 in)  | 48 (105.8) |

# HWT 600 WD













|                   |  |  |  |  |  |  |  |  |  |          |
|-------------------|---|---|---|---|---|---|---|---|---|----------|
|                   |   | HP-kW   | CC  | L (US qts)  |   |   |   |   | kg (lb)   |          |
| <b>HWT 600 WD</b> | GCV 170<br>Honda  | HP4.8 - kW3.6   | 166/1   | 0,9 (0.95)  |  | 2,5 km/h<br>(1.5 mph)   | 41 cm<br>(16.2 in)  | 15-30-50-60<br>mm<br>(0.6-1.2-2-2.4 in)   | 60 cm<br>(24 in)  | 47 (104) |

# HWT 700









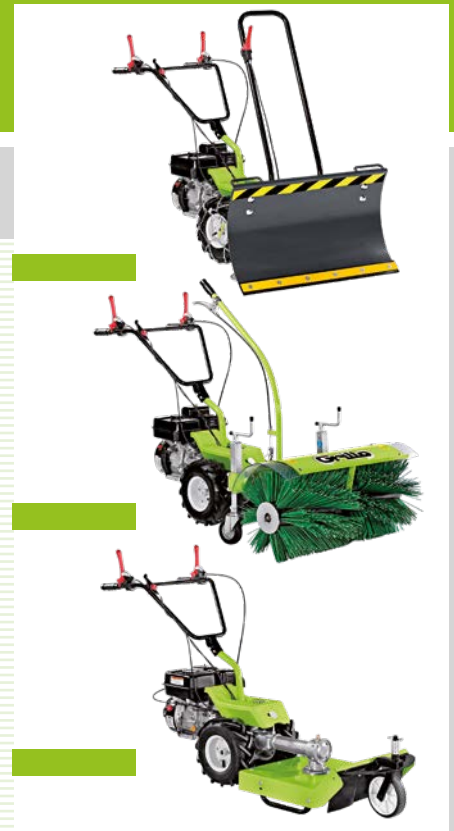

## SUPERTRAC



|                          |  |  |  |  |  |  |  |  |  |  |
|--------------------------|---|---|---|---|---|---|---|---|---|---|
| <b>HWT 700 SUPERTRAC</b> | F1180V KAI<br>Kawasaki  | HP 4.5 - kW 3.4   | 179/1   | 1,7 (1.5)<br>L (US qts)   |  | 2,5 km/h<br>(1.5 mph)   | 3.50-8<br><br>38 cm<br>(14.9 in)  | 15-30-50-60<br>mm<br>(0.6-1.2-2-2.4 in)   | 60 cm<br>(24 in)  | 62 (137)<br>kg (lb)   |

# GF 1



|             |  |  |  |  |  |  |  |  |  |  |
|-------------|---|---|---|---|---|---|---|---|---|---|
| <b>GF 1</b> | G 200 FA<br>Loncin  | HP 5.5 - kW 4.1   | 196/1   | 3 (3.2)<br>L (US qts)   |  | 13x5.00-6   | 2,20 km/h<br>(1.4 mph)  | -   | 86-96cm<br>(34-38 in)   | 70 (154)<br>kg (lb)   |

# GF 2































|      |  | HP-kW           |  | <br>L (US qts) |  |  |   |    |  | <br>kg (lb) |
|------|---|-----------------|---|---|---|---|--|---|---|--|
| GF 2 | G 200 FA<br>Loncin  | HP 5.5 - kW 4.1 | 196/1   |                |  |   |  4.00-8  |  4.00-8  | 110-117 cm<br>(43-46 in)  | 98 (216)   |
|      | GX 200<br>Honda   | HP 5.5 - kW 4.1 | 196/1   |                |  |   |  1,0 km/h<br>(0.6 mph)<br> 2,0 km/h<br>(1.2 mph)<br> 3,0 km/h<br>(1.9 mph) |  1,0 km/h<br>(0.6 mph)<br> 2,0 km/h<br>(1.2 mph)<br> 3,0 km/h<br>(1.9 mph) |   | 96 (212)   |

# GF 3 - GF 3DF













GF 3DF



|        |  | HP-kW           | CC  | <br>L (US qts) |  | <br>Steering Brakes | <br>DIFF. LOCK |                        |                        |  | <br>kg (lb) |
|--------|---|-----------------|--|---|---|--|---|---|---|---|--|
| GF 3   | G 300 FA<br>Loncin  | HP 9.3 - kW 6.8 | 302/1  | 6,1 (6.4)   |  | -  | -   |  4.00-8                |  4.00-8                | 110-117<br>127-132-137<br>cm<br>(43-46-50-52-<br>54 in)                               | 105 (231)  |
|        | GX 270<br>Honda   | HP 8.4 - kW 6.3 | 270/1  | 5,3 (5.6)   |  | -  | -   |  1,0 km/h<br>(0.6 mph) |  1,0 km/h<br>(0.6 mph) |   | 103 (227)  |
|        | SH178 FA<br>Norwik  | HP 5.3 - kW 4   | 306/1  | 3,5 (3.6)   |  | -  | -   |  2,0 km/h<br>(1.2 mph) |  2,0 km/h<br>(1.2 mph) |   | 115 (254)  |
| GF 3DF | G 300 FA<br>Loncin  | HP 9.3 - kW 6.8 | 302/1  | 6,1 (6.4)   |  |                     |                |  3,0 km/h<br>(1.9 mph) |  3,0 km/h<br>(1.9 mph) |   | 112 (245)  |
|        | GX 270<br>Honda   | HP 8.4 - kW 6.3 | 270/1  | 5,3 (5.6)   |  |                     |                |  3,0 km/h<br>(1.9 mph) |  3,0 km/h<br>(1.9 mph) |   | 110 (243)  |
|        | SH178 FA<br>Norwik  | HP 5.3 - kW 4   | 306/1  | 3,5 (3.6)   |  |                     |                |   |   |   | 122 (269)  |













# GH 8



|             |  |  |  |  |  |  |  |  |  |  |
|-------------|---|---|---|---|---|---|---|---|---|---|
|             |   | HP-kW   | CC  | L (US qts)  |   | HYDROSTATIC   |   |   |   | kg (lb)   |
| <b>GH 8</b> | G 200 FA<br>Loncin  | HP 5.5 - kW 4.1   | 196/1   | 3 (3.2)   |  | 0 - 6 km/h<br>(0 - 3.7 mph)   | 0 - 3 km/h<br>(0 - 1.9 mph)   | 20...60 mm<br>(0.78...2.36 in)  | 58 cm<br>(22.8 in)  | 135 (297)   |













# GH 9



|             |  |  |  |  |  |  |  |  |  |  |
|-------------|---|---|---|---|---|--|---|---|---|---|
| <b>GH 9</b> | GX 270<br>Honda   | HP 8.4 - kW 6.3   | 270/1   |  |  | <b>HYDROSTATIC</b>   |   | 30...110 mm<br>(1.2...4.3 in)   | 68 cm<br>(26.8 in)  | 158 (348)   |
|             |   |   |   |   |   | 0 - 6 km/h<br>(0 - 3.7 mph)  | 0 - 3 km/h<br>(0 - 1.9 mph)   |   | 85 cm<br>(33.5 in)  | 165 (364)   |

# CL 62M



|               |  |  |  |  |  |  |  |  |  |  |
|---------------|---|---|---|---|---|---|---|---|---|---|
|               |   | HP-kW   | CC  | L (US qts)  |  | HYDROSTATIC   |   |   |   | kg (lb)   |
| <b>CL 62M</b> | FJ180V<br>Kawasaki  | HP 4.5 - kW 3.4   | 179/1   | 1,6 (1.5)   |  | 0 - 4,7 km/h<br>(0 - 2.9 mph)   | 0 - 3 km/h<br>(0 - 1.9 mph)   | 50...110 mm<br>(2.0...4.3 in)   | 62 cm<br>(24.4 in)  | 98 (216)  |

# CL 75

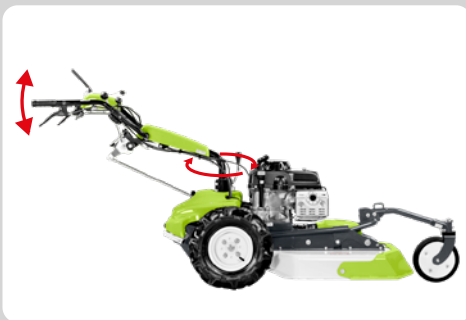

|              |                  | HP-kW            | CC    | L (US qts) |  | DIFF. LOCK |                             |                               |                               |                    | kg (lb)   |
|--------------|------------------|------------------|-------|------------|--|------------|-----------------------------|-------------------------------|-------------------------------|--------------------|-----------|
| <b>CL 75</b> | GXV 390<br>Honda | HP 10.2 - kW 7.6 | 389/1 | 2,1 (2.2)  |  | ✓          | <b>HYDROSTATIC</b>          |                               |                               |                    |           |
|              |                  |                  |       |            |  |            | 0 - 6 km/h<br>(0 - 3.7 mph) | 0 - 3,5 km/h<br>(0 - 2.2 mph) | 50...150 mm<br>(2.0...5.9 in) | 75 cm<br>(29.5 in) | 140 (309) |

# CLIMBER 7

## 7.15 - 7.18



CLIMBER 7.18















CLIMBER 7.18



CLIMBER 7.15



|             |  | HP-kW                    |  | <br>L (US qts) | <br>DIFF. LOCK | <br>HYDROSTATIC |  |  |  | <br>kg (lb) |
|-------------|---|--------------------------|---|---|---|--|---|---|---|--|
| <b>7.15</b> | LC1P92F<br>Loncin   | HP 12 (*15)<br>kW 9.2    | 452/1   | <br>7 (7.4)    |                | 0 - 9 km/h<br>(0 - 5.6 mph)  | 45 cm<br>(18 in)  | 35...85 mm<br>(1.3...3.3 in)  | 85 cm<br>(33.5 in)  | 250 (551)  |
| <b>7.18</b> | 7160<br>EXi INTEK<br>B&S  | HP 15.2 (*18)<br>kW 11.2 | 656/2   | <br>7 (7.4)    |                | 0 - 9 km/h<br>(0 - 5.6 mph)  | 45 cm<br>(18 in)  | 35...85 mm<br>(1.3...3.3 in)  | 85 cm<br>(33.5 in)  | 255 (562)  |

\* Gross Power









# CLIMBER 8

## 8.22



KIT MULCHING



|      |  | HP-kW                  |  | <br>L (US qts) | <br>DIFF. LOCK | <br>HYDROSTATIC |  |  | <br>kg (lb) |           |
|------|---|------------------------|---|---|---|--|---|---|--|-----------|
| 8.22 | 7220<br>PXi<br>PROFESSIONAL<br>B&S  | HP 18 (*22)<br>kW 13.2 | 656/2   | 7 (7.4)   | ✓   | 0 - 10 km/h<br>(0 - 6.2 mph)   | 60 cm<br>(23.6 in)  | 35...110 mm<br>(1.3...4.3 in)   | 91 cm<br>(36 in)   | 290 (639) |

# CLIMBER 9

## 9.18 - 9.22s



CLIMBER 9.18











CLIMBER 9.22s



CLIMBER 9.18



KIT MULCHING

|              |  | HP-kW                  |  | <br>L (US qts) |  |  |  |  |  |  |
|--------------|---|------------------------|---|---|---|---|---|---|---|---|
| <b>9.18</b>  | 7160<br>EXi INTEK<br>B&S  | HP15.2 (*18)<br>kW11.2 | 656/2   | 13 (13.7)   | ✓   | HYDROSTATIC<br>0 - 10 km/h<br>(0 - 6.2 mph)   | 38 cm<br>(15 in)  | 30...90 mm<br>(1.2...3.5 in)  | 91 cm<br>(36 in)  | 297 (655)   |
| <b>9.22s</b> | 7220<br>PXi<br>PROFESSIONAL<br>B&S  | HP18 (*22)<br>kW13.2   | 656/2   | 13 (13.7)   | ✓   | HYDROSTATIC<br>0 - 10 km/h<br>(0 - 6.2 mph)   | 38 cm<br>(15 in)  | 30...90 mm<br>(1.2...3.5 in)  | 91 cm<br>(36 in)  | 310 (683)   |

\* Gross Power

# CLIMBER 10

## AWD 27- AWD 23



CLIMBER 10 AWD 23



CLIMBER 10 AWD 27















AWD 27











AWD 23



|               |  | HP-kW                  |  | <br>L (US qts) | <br>DIFF. LOCK | <br>HYDROSTATIC |  |  |  | <br>kg (lb) |
|---------------|---|------------------------|---|---|---|--|---|---|---|--|
| <b>AWD 23</b> | LC2P77F<br>Loncin   | HP22<br>kW 16          | 780/2   | <br>13 (13.7)  |                | 0 - 9 km/h<br>(0 - 5.6 mph)  | 95 cm<br>(37.4 in)  | 35...135 mm<br>(1.4...5.3 in)   | 93 cm<br>(36.6 in)  | 350 (772)  |
| <b>AWD 27</b> | 8290 CXi<br>COMMERCIAL<br>B&S   | HP 22 (*27)<br>kW 16.2 | 724/2   | <br>13 (13.7)  |                | 0 - 9 km/h<br>(0 - 5.6 mph)  | 95 cm<br>(37.4 in)  | 35...135 mm<br>(1.4...5.3 in)   | 98 cm<br>(38.6 in)  | 385 (849)  |

# FK 700



|               |  | <b>HP-kW</b>  |  | <br>L (US qts) | <br>DIFF. LOCK |  |  |  |  | <br>kg (lb) |
|---------------|---|---------------|---|---|---|---|---|---|---|--|
| <b>FK 700</b> | D 722 E4B<br>Kubota   | HP 18 kW/13.2 | 722/3   | Diesel<br><b>31 (8.1)</b>   | ✓   | 0 - 15 km/h<br>(fast)<br>0 - 8 km/h<br>(slow)                                       | 37 cm<br>(14.5 in)  | 0...100 mm<br>(0...3.9 in)  | 115 cm<br>(45.2 in)   | 615 (1356)   |

# MD 15-MD 18



MD 15



MD 15



MD 18



MD 18









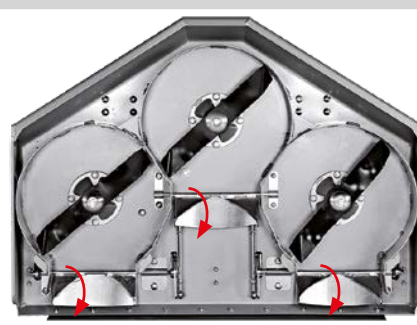

MD 18

|              |                          | HP-kW                    |       |            |            |                             |                  |                              |                    |           |
|--------------|--------------------------|--------------------------|-------|------------|------------|-----------------------------|------------------|------------------------------|--------------------|-----------|
|              |                          |                          | CC    | L (US qts) | DIFF. LOCK | HYDROSTATIC                 |                  |                              | QUICK SHIFT        | kg (lb)   |
| <b>MD 15</b> | LC1P92F<br>Loncin        | HP 12 (*15)<br>kW 9.2    | 452/1 |            | --         | 0 - 9 km/h<br>(0 - 5.6 mph) | 45 cm<br>(18 in) | 25...75 mm<br>(1.0...3.3 in) | 83 cm<br>(32.6 in) | 235 (518) |
| <b>MD 18</b> | 7160<br>EXI INTEK<br>B&S | HP 15.2 (*18)<br>kW 11.2 | 656/2 |            |            | 0 - 9 km/h<br>(0 - 5.6 mph) | 45 cm<br>(18 in) | 25...80 mm<br>(1.0...3.5 in) | 83 cm<br>(32.6 in) | 238 (525) |

# MD 22N













|               |  | <b>HP-kW</b>           |  | <br>L (US qts) | <br>DIFF. LOCK |  |  |  | <br>QUICK SHIFT | <br>kg (lb) |
|---------------|---|------------------------|---|---|---|---|---|---|--|--|
| <b>MD 22N</b> | 7220<br>PXi<br>PROFESSIONAL<br>B&S  | HP 18 (*22)<br>kW 13.2 | 656/2   | 7 (7.4)   | ✓   | HYDROSTATIC<br>0 - 10,5 km/h<br>(0 - 6.5 mph)                                       | 60 cm<br>(23.6 in)  | 25...110 mm<br>(0.9...4.3 in)   | 106 cm<br>(41.7 in)  | 315 (694)  |

\* Gross Power

# MD 24 AWD













|                  |  |  |  |  |  |  |  |  |  |  |
|------------------|---|---|---|---|---|---|---|---|---|---|
| <b>MD 24 AWD</b> | 7220<br>PXi<br>PROFESSIONAL<br>B&S  | HP 18 (*22)<br>KW 13.2  | 656/2   | 13 (11.8)   | ✓   | HYDROSTATIC<br>0-9 km/h<br>(0 - 5.6 mph)  | 95 cm<br>(37.4 in)  | 25...110 mm<br>(0.9...4.3 in)   | QUICK SHIFT<br>106 cm<br>(41.7 in)  | 370 (816)   |

# MD 28 AWD



MD 24 AWD













|                  |  |  |  |  |  |  |  |  |  |  |
|------------------|---|---|---|---|---|---|---|---|---|---|
|                  |   | HP-kW   | CC  | L (US qts)  | DIFF. LOCK  | HYDROSTATIC   |   |   | QUICK SHIFT   | kg (lb)   |
| <b>MD 28 AWD</b> | 8290 CXi<br>COMMERCIAL<br>B&S   | HP 22 (*27)<br>KW 16.2  | 724/2   | 13 (11.8)   | ✓   | 0-9 km/h<br>(0 - 5.6 mph)   | 95 cm<br>(37.4 in)  | 25...110 mm<br>(0.9...4.3 in)   | 125 cm<br>(49.2 in)   | 389 (856)   |

\* Gross Power

# FX 27

## Zero-Turn













|              |  |  |  |  |  |  |  |  |  |  |
|--------------|---|---|---|---|---|---|---|---|---|---|
|              | 8290 CXi<br>COMMERCIAL<br>B&S   | HP.22 (*27)<br>kW 16.2  | 724/2   | 30 (7.9)  | HYDROSTATIC   | ZERO TURN   | ELECTRIC  | QUICK SHIFT   | 484 (1067)  | H 170 cm<br>D 132 cm<br>W 258 cm  |
| <b>FX 27</b> |   |   |   |   |   |   |   |   |   |   |

# FD 220E













## Full Electric



|                |  |  |  |  |  |  |  |  |  |  |  |
|----------------|---|---|---|---|---|---|--|---|---|---|---|
|                | MAX POWER   | DEC POWER   | TRACTION POWER  | BATTERY CAPACITY  |   |   |  |   |   | kg (lb)   | H D W   |
| <b>FD 220E</b> | 11.7 kW   | 10 kW   | 1.7 kW  | 7.7 kWh   | 0 - 10 km/h<br>(0 - 6.2 mph)  | 200 L<br>5.7 (US bu)  | 30 cm<br>(11.8 in)   | 25...90 mm<br>(1.0...3.5 in)  | 80 cm<br>(31 in)  | 316<br>(696.6)  | H 114 cm<br>D 86 cm<br>W 234 cm   |

# FD 220R



|                |  | <b>HP-kW</b>           |  | <br>L (US qts) |  |  |  |  |  | <br>kg (lb) |  |
|----------------|---|------------------------|---|---|---|---|--|---|---|--|---|
| <b>FD 220R</b> | LC1P92F<br>Loncin   | HP 12 (*15)<br>kW 9.2  | 452/1   | <br>7 (7.4)    | <b>HYDROSTATIC</b><br>0 - 9 km/h<br>(0 - 5.6 mph)                                   | 200 L<br>5.7 (US bu)  | 30 cm<br>(11.8 in)   | 30...90 mm<br>(1.2...3.5 in)  | 80 cm<br>(31 in)  | 263 (580)  | H 114 cm<br>D 86 cm<br>W 234 cm   |
|                | VANGUARD 16<br>B&S  | HP 14 (*16)<br>kW 10.3 | 479/2   | <br>7 (7.4)    | <b>HYDROSTATIC</b><br>0 - 9 km/h<br>(0 - 5.6 mph)                                   | 200 L<br>5.7 (US bu)  | 30 cm<br>(11.8 in)   | 30...90 mm<br>(1.2...3.5 in)  | 80 cm<br>(31 in)  | 270 (595)  |   |

# FD 280



|               |                    | HP-kW                  |       |         |   |             |          |                    |                              |                   |           |                                  |
|---------------|--------------------|------------------------|-------|---------|---|-------------|----------|--------------------|------------------------------|-------------------|-----------|----------------------------------|
| <b>FD 280</b> | VANGUARD 16<br>B&S | HP 14 (*16)<br>kW 10.3 | 479/2 | 8 (8.4) | ✓ | HYDROSTATIC | ELECTRIC | 30 cm<br>(11.8 in) | 30...90 mm<br>(1.2...3.5 in) | 113 cm<br>(44 in) | 320 (705) | H 120 cm<br>D 119 cm<br>W 238 cm |

\* Gross Power

# FD 450



|               |                                    |                        |            |          |            |                              |                       |                    |                              |                   |           |   |
|---------------|------------------------------------|------------------------|------------|----------|------------|------------------------------|-----------------------|--------------------|------------------------------|-------------------|-----------|---|
|               |                                    |                        |            |          |            |                              |                       |                    |                              |                   |           |   |
|               | HP-kW                              | CC                     | L (US Gal) | DIESEL   | DIFF. LOCK | HYDROSTATIC                  | HYDRAULIC             | HYDRAULIC          | ELECTRIC                     |                   | kg (lb)   | H <sup>1</sup> 194 cm<br>H 146 cm<br>D 119 cm<br>W 268 cm |
| <b>FD 450</b> | 7220<br>PXi<br>PROFESSIONAL<br>B&S | HP 18 (*22)<br>kW 13.2 | 656/2      | 17 (4.5) | ✓          | 0 - 11 km/h<br>(0 - 6.8 mph) | 450 L<br>12.8 (US bu) | 30 cm<br>(11.8 in) | 25...90 mm<br>(1.0...3.5 in) | 113 cm<br>(44 in) | 450 (992) |   |

# FD 500









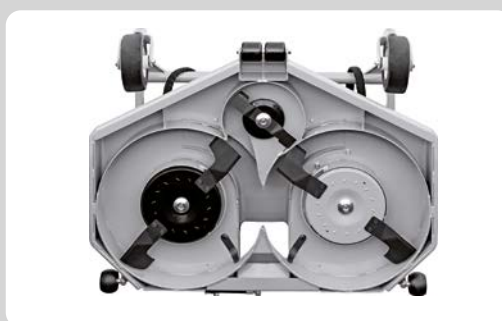





|               |                     |                 |       |                    |   |                            |                       |                    |  |                     |            |   |
|---------------|---------------------|-----------------|-------|--------------------|---|----------------------------|-----------------------|--------------------|--|---------------------|------------|---|
|               |                     |                 |       |                    |   |                            |                       |                    |  |                     |            |   |
| <b>FD 500</b> | D 722 E4B<br>Kubota | HP 18 - kW 13.2 | 722/3 | Diesel<br>22 (5.8) | ✓ | 0 - 13 km/h<br>(0 - 8 mph) | 700 L<br>19.8 (US bu) | 32 cm<br>(12.5 in) | <b>ELECTRIC</b><br>25....90 mm<br>(0.9...3.5 in) | 113 cm<br>(44.4 in) | 610 (1345) | H <sup>1</sup> 193 cm<br>H 151 cm<br>D 119 cm<br>W 271 cm |

# FD 900

## 4WD













|                       |  |  |  |  |  |  |  |  |  |  |  |  |
|-----------------------|---|---|---|---|---|---|---|--|---|---|---|---|
|                       |   | HP-kW   | CC  | L (US Gal)  | DIFF. LOCK  | HYDROSTATIC   | HYDRAULIC   | HYDRAULIC  | HYDRAULIC   |   | kg (lb)   | H <sup>1</sup> 207 cm<br>H 166 cm<br>D 133 cm<br>W 291 cm                             |
| <b>FD 900<br/>4WD</b> | 3TNV80F<br>Yanmar   | HP 25 - kW 18.4   | 1267/3  | Diesel<br>31 (8.2)  | ✓   | 0 - 15 km/h<br>(0 - 9 mph)  | 750 L<br>21.3 (US bu)   | 37 cm<br>(14.6 in)   | 20...100 mm<br>(0.8...3.9 in)   | 126 cm<br>(49.6 in)   | 980 (2160)  |   |

# FD 13.09

## 4WD













|                               |  | HP-kW           |  | <br>L (US Gal) | <br>DIFF. LOCK |  |  |  |  |  | <br>kg (lb) |  |   |
|-------------------------------|---|-----------------|---|---|---|---|---|--|---|---|--|---|---|
| <b>FD 13.09</b><br><b>4WD</b> | 3TNV82A<br>Yanmar   | HP 26 - kW 18.9 | 1331/3  | Diesel<br><b>23 (6.0)</b>   | ✓   | 0 - 15 km/h<br>(0 - 9.3 mph)  | 900 L<br>25.5 (US bu)   | 31 cm<br>(12 in)   | HYDRAULIC   | 20...100 mm<br>(0.8...3.9 in)   | 132 cm<br>(52 in)  | 1230 (2712)   | H <sup>1</sup> 213 cm<br>H 175 cm<br>D 141 cm<br>W 325 cm |
|                               |   |                 |   |   |   |   |   |  | HYDRAULIC   | 20...120 mm<br>(0.8...4.7 in)   | 152 cm<br>(59.8 in)  | 1310 (2888)   | H <sup>1</sup> 213 cm<br>H 175 cm<br>D 162 cm<br>W 340 cm |

# FD 2200

## 4WD













|                        |  | HP-kW            |  | <br>L (US Gal) | <br>DIFF. LOCK | <br>HYDROSTATIC | <br>HYDRAULIC | <br>HYDRAULIC |  |  | <br>kg (lb) |  |
|------------------------|---|------------------|---|---|---|--|--|---|---|---|--|---|
| <b>FD 2200<br/>4WD</b> | 3TNV88C<br>Yanmar   | HP 37<br>kW 27.5 | 1642/3  | Diesel<br>50 (13.2)   | ✓   | 0 - 20 km/h<br>(0 - 12.4 mph)  | 1200 L<br>34 (US bu)   | 62 cm<br>(24 in)  | 25...110 mm<br>(0.9...4.3 in)   | 152 cm<br>(59.8 in)   | 1490 (3285)  | H <sup>+</sup> 243cm<br>H 183 cm<br>D 162 cm<br>W 347 cm                              |

# FD 2200 TS

## 4WD













|                                     |  | HP-kW            |  | <br>L (US Gal) | <br>DIFF. LOCK | <br>HYDROSTATIC | <br>HYDRAULIC | <br>HYDRAULIC | <br>HYDRAULIC | <br>HYDRAULIC | <br>kg (lb) |  |
|-------------------------------------|---|------------------|---|---|---|--|--|---|--|--|--|---|
| <b>FD 2200</b><br>TOP SCORER<br>4WD | 4TNV88C<br>Yanmar   | HP 47<br>kW 34.3 | 2190/4  | Diesel<br><b>50 (13.2)</b>  | ✓   | 0 - 21 km/h<br>(0 - 13.6 mph)  | 1400 L<br>39.7 (US bu)   | 60 cm<br>(24 in)  | 20...120 mm<br>(0.8...4.7 in)  | 152 cm<br>(59.8 in)  | 1656 (3651)  | H <sup>1</sup> 231 cm<br>H 199 cm<br>D 162 cm<br>W 364 cm                             |
|                                     |   |                  |   |   |   |  |  |   | 182 cm<br>(71.6 in)  | 1705 (3758)  |  | H <sup>1</sup> 231 cm<br>H 199 cm<br>D 194 cm<br>W 369 cm                             |

# FM 13.09

## 4WD













|                               |  | HP-kW       |  | <br>L (US Gal) | <br>DIFF. LOCK | <br>HYDROSTATIC |  | <br>HYDRAULIC |  | <br>LMP | <br>kg (lb) |  |
|-------------------------------|---|-------------|---|---|---|--|---|---|---|--|--|---|
| <b>FM 13.09</b><br><b>4WD</b> | 3TNV82A<br>Yanmar   | HP26-kW18.9 | 1331/3  | Diesel<br>23 (6.0)  | ✓   | 0 - 15 km/h<br>(0 - 9.3 mph)   | 12000<br>m <sup>2</sup> /h  | 31 cm<br>(12 in)  | 20...100 mm<br>(0.8...3.9 in)   | 160 cm<br>(63 in)  | 1150 (2535)  | H <sup>+</sup> 213 cm<br>H 175 cm<br>D 192 cm<br>W 299 cm                             |

# FM 2200

## 4WD



|                        |  | HP-kW            |  | <br>L (US Gal) |  |  |  |  |  |  |  |  |
|------------------------|---|------------------|---|---|---|---|---|--|---|---|---|---|
| <b>FM 2200<br/>4WD</b> | 3TNV88C<br>Yanmar   | HP 37<br>kW 27.5 | 1642/3  | Diesel<br><b>50 (13.2)</b>  | ✓   | HYDROSTATIC<br>0 - 20 km/h<br>(0 - 12.4 mph)  | 15500<br>m <sup>2</sup> /h  | HYDRAULIC<br>62 cm<br>(24 in)  | 20...90 mm<br>(0.8...3.5 in)  | LMP<br>160 cm<br>(63 in)  | 1322 (2915)   | H <sup>+</sup> 243 cm<br>H 183 cm<br>D 192 cm<br>W 347 cm                             |



Nell'ottica di un costante sviluppo dei propri prodotti, Grillo Spa si riserva il diritto di cambiare le specifiche tecniche e le illustrazioni su questo documento e senza preavviso ne obbligo. Foto e caratteristiche non contrattuali. In his pursuit of constant development of his products, Grillo Spa reserves the right to change the technical specifications and the illustrations on this document, at any given moment and without any kind of obligation. All the pictures characteristics are not contract-binding. En poursuivant une politique constante d'amélioration de ses produits, Grillo Spa se réserve le droit de modifier les spécifications techniques en tout temps sans préavis ni obligation. Photographies et caractéristiques non contractuelles. Aufgrund ständiger Weiterentwicklung behält sich Grillo Spa Änderungen in Form, Technik und Ausstattung der Produktpalette vor. Aus Angaben und Abbildungen des vorliegenden Grillo-Katalogs können daher keine Ansprüche abgeleitet werden. En vista de un desarrollo constante de sus productos, Grillo Spa se reserva el derecho de cambiar las especificaciones técnicas y las ilustraciones mostradas en este documento en cualquier momento y sin aviso previo. Las fotos y características no son contractuales.



**Grillo**  
AGRIGARDEN  
MACHINES

www.grillospa.it



grillo@grillospa.it  
Tel. (+39) 0547.633111



GrilloSpa



Grillo Spa



grillo.spa